

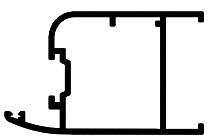

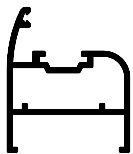





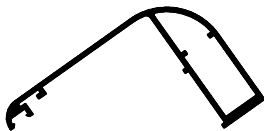
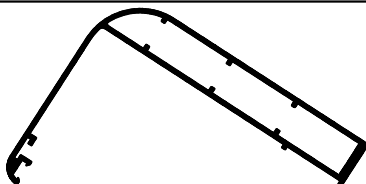
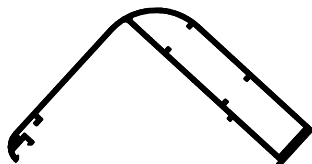
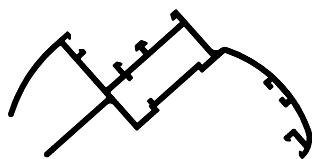
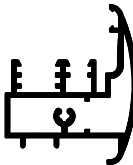
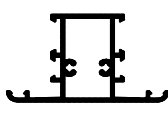

Linea Mediterranea-Porte Interne

ARTICOLO	SEZIONE	PESO gr/ml	DESCRIZIONE
R 4552		995	ANTA PORTA MAGGIORATO
R 4553		830	ANTA PORTA
R 4554		472	RIDUTTORE DA 10 mm
R 4555		468	RIDUTTORE DA 24 mm
R 4556		1260	FASCIA DA 100 mm
R 4557		958	IMBOTTO DA 90 A 120 mm
R 4558		1414	IMBOTTO DA 150 A 180 mm
R 4559		1186	IMBOTTO DA 130 A 190 mm
R 4560		1300	TELAIO PORTA
R 4340		1184	INVERSIONE PER PORTA DOPPIA

Linea Mediterranea-Porte Interne

ARTICOLO	SEZIONE	PESO gr/ml	DESCRIZIONE
R 3598		1051	TRAVERSO
R 0521		266	FERMAVETRO TESTA 14 mm
R 0522		277	FERMAVETRO TESTA 18 mm
R 0523		294	FERMAVETRO TESTA 22 mm
R 0524		314	FERMAVETRO TESTA 26 mm
R 0525		350	FERMAVETRO TESTA 30 mm
R 0533		252	FERMAPANNELLO TESTA 5 mm

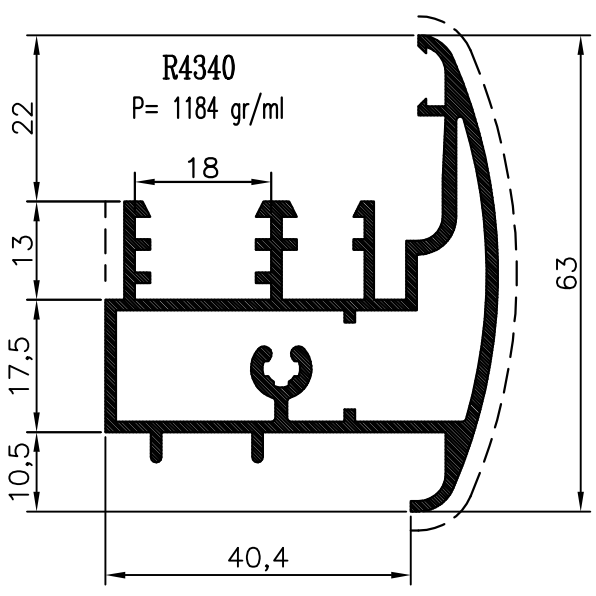
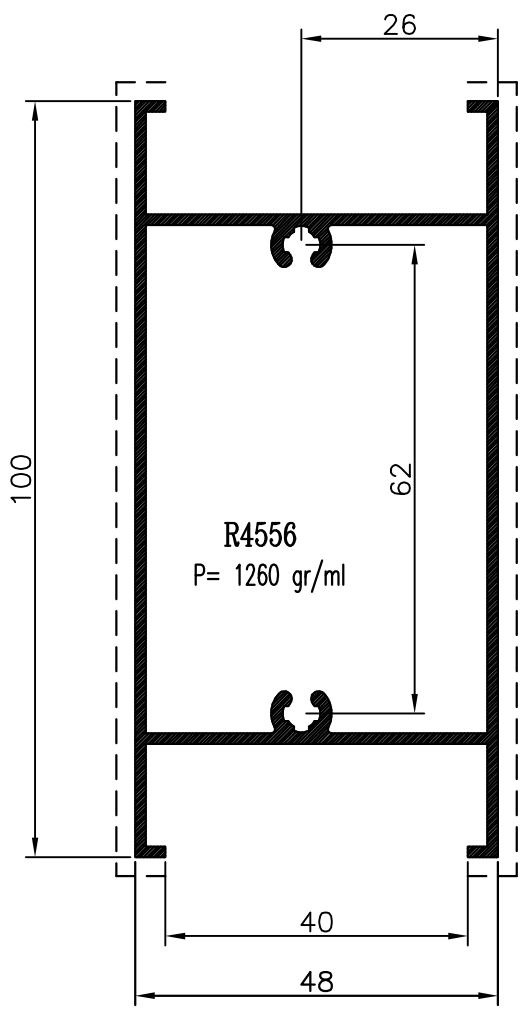
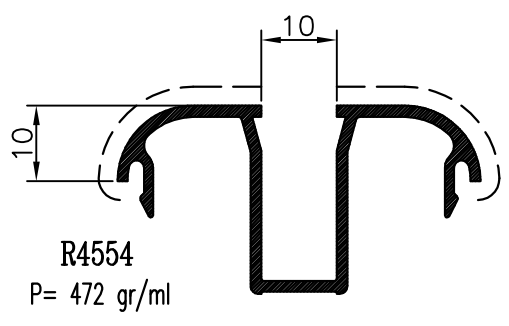
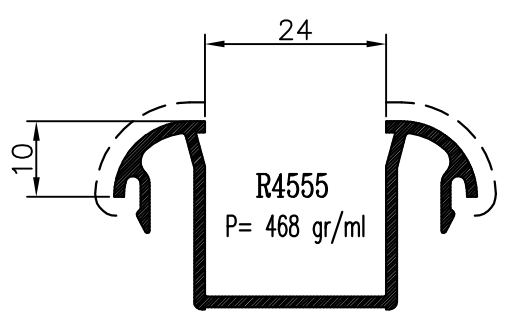
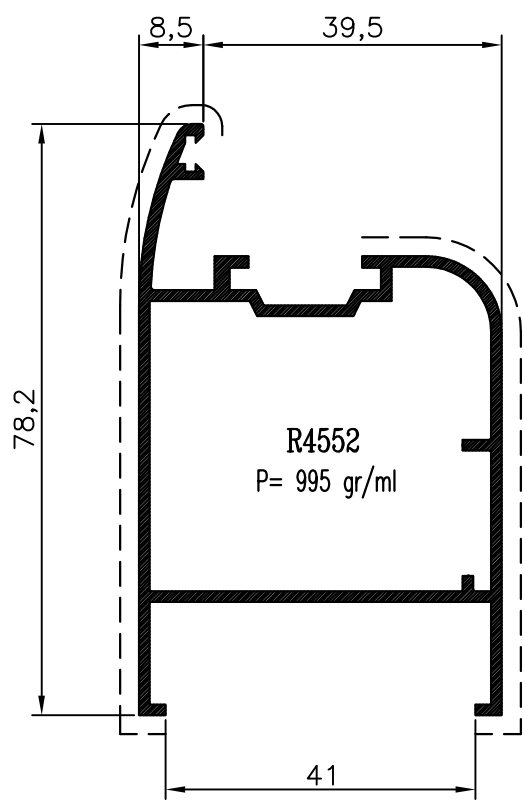
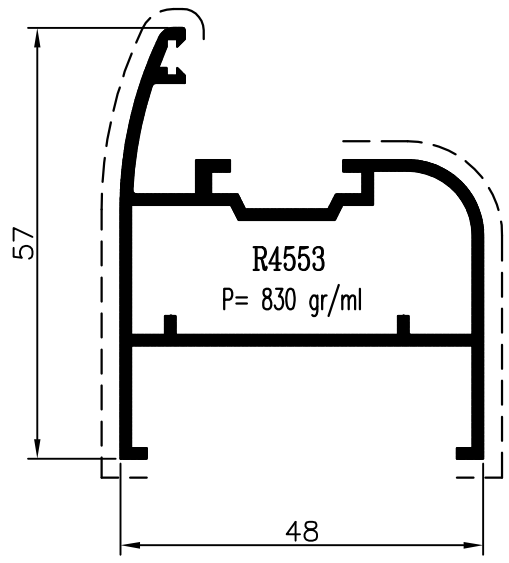

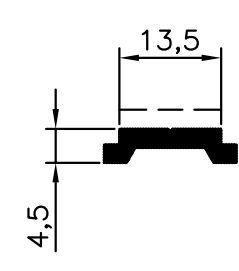
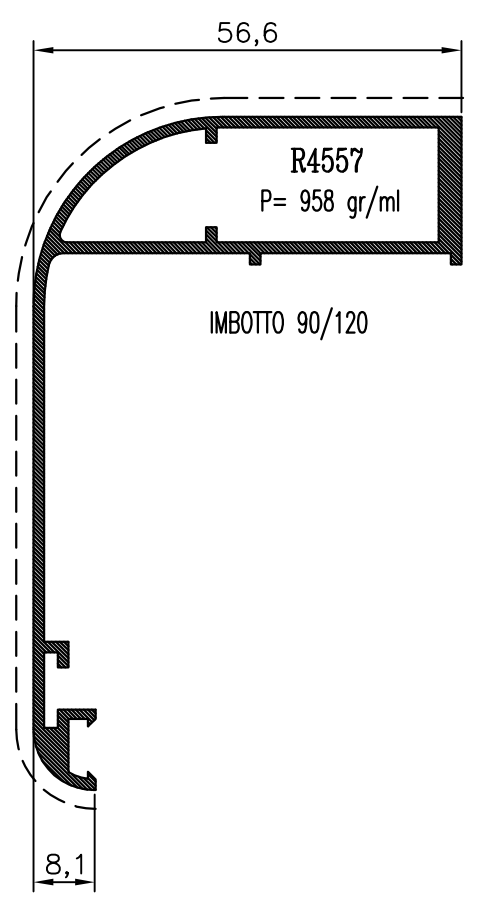
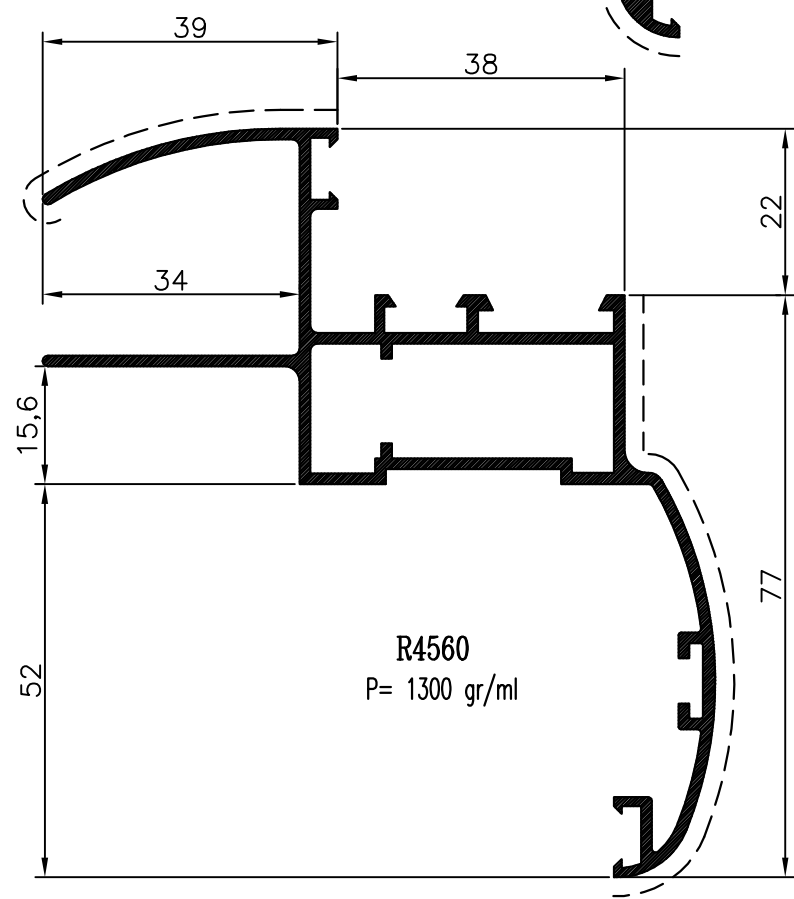
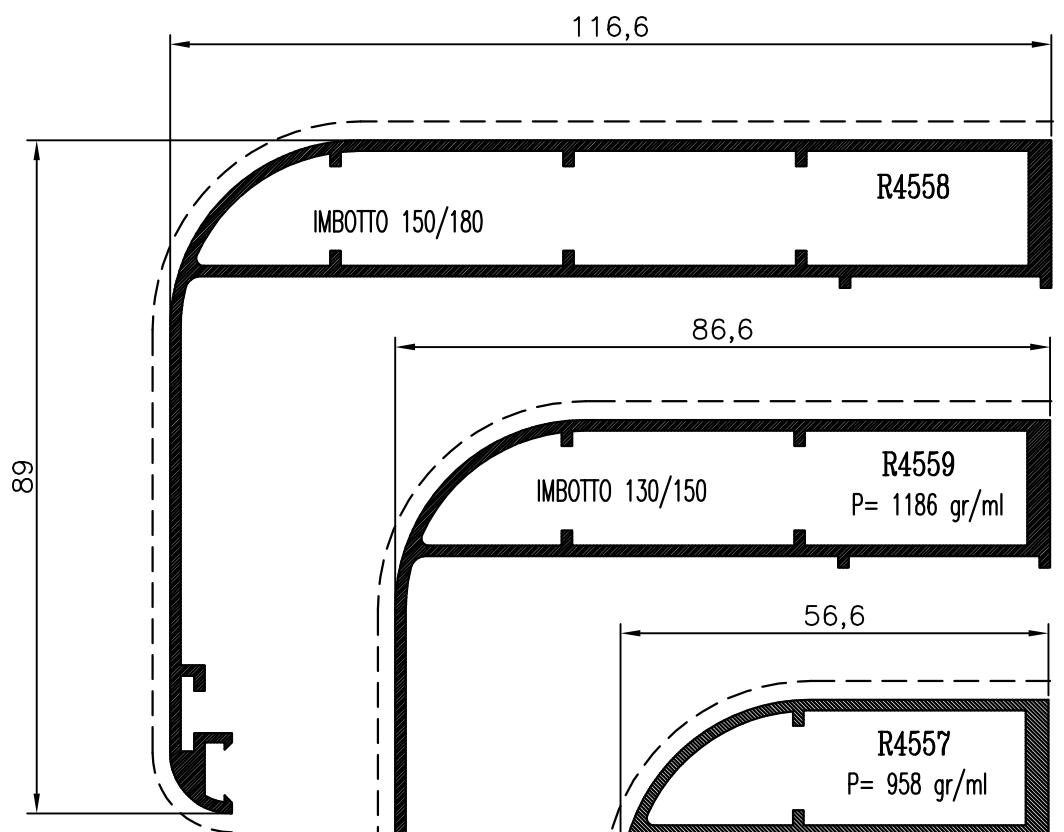



R0533
P= 266 gr/ml

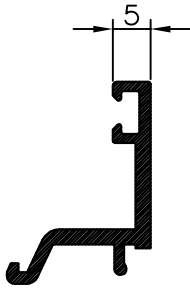

R0521
P= 266 gr/ml

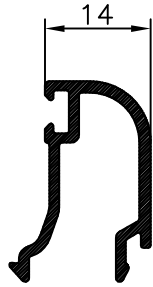

R0522
P= 277 gr/ml

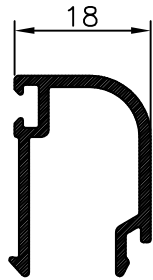

R0523
P= 294 gr/ml

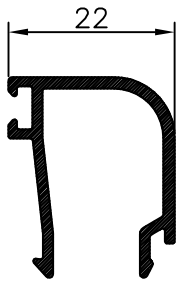

R0524
P= 314 gr/ml

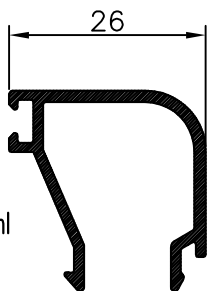

R0525
P= 350 gr/ml

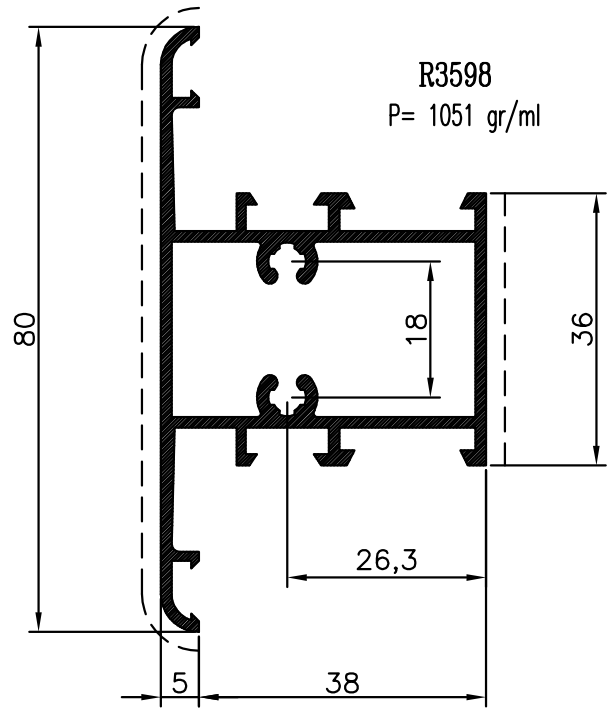
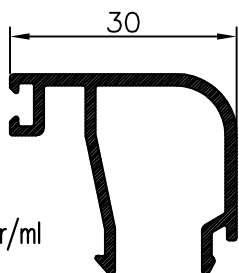

Pannellature parti fisse

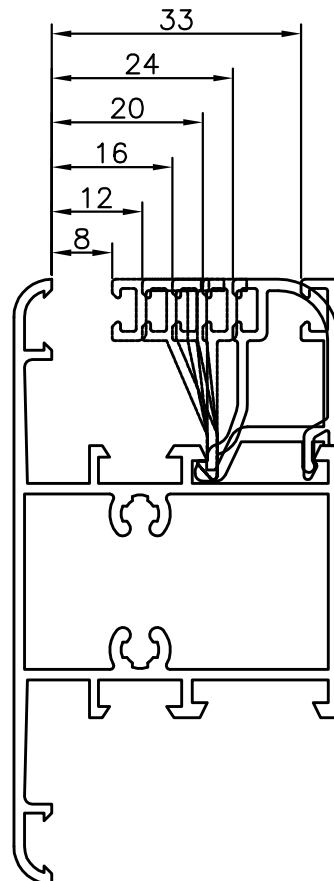



SEZIONE ORIZZONTALE - Porta 1 anta Vetro

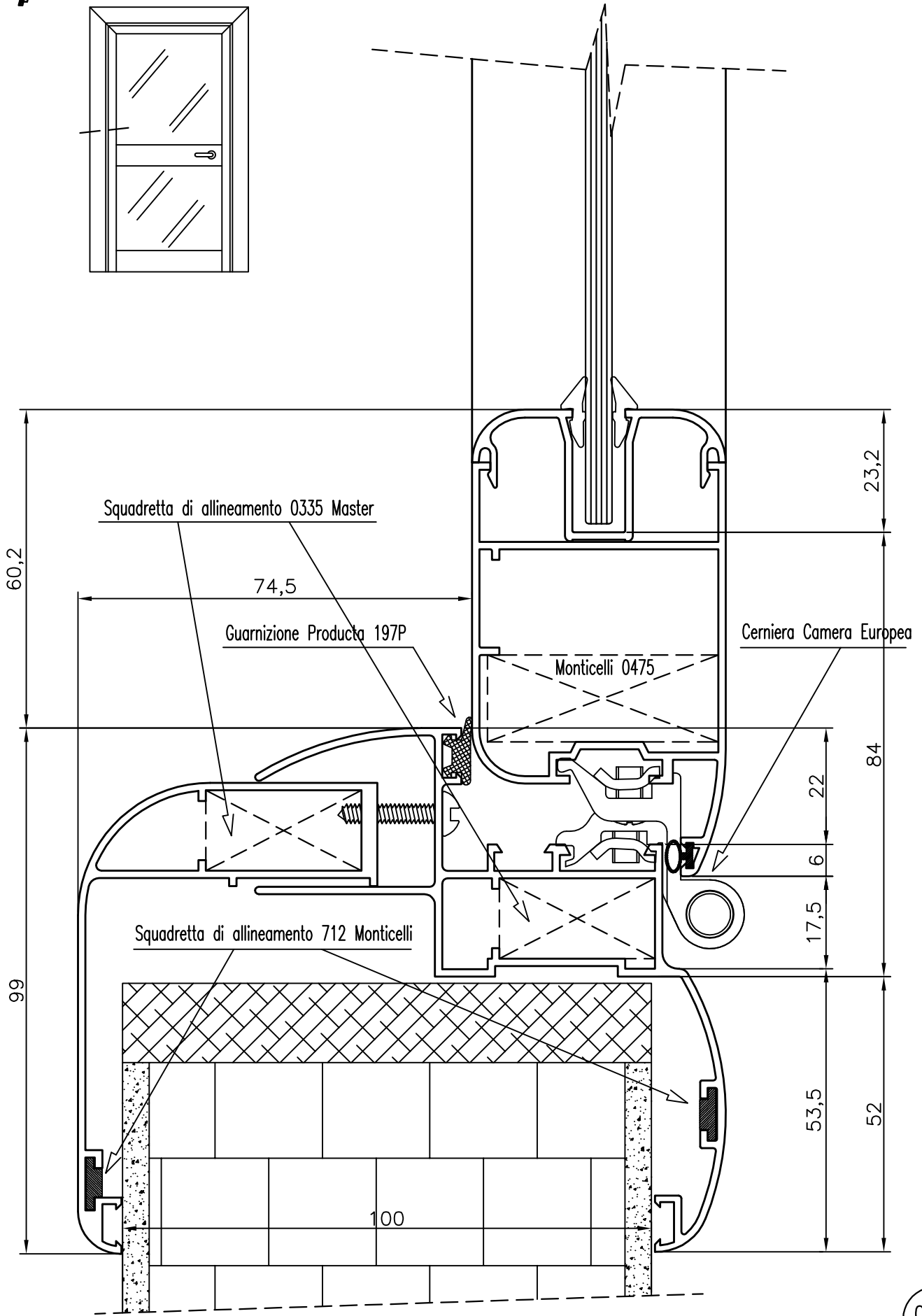
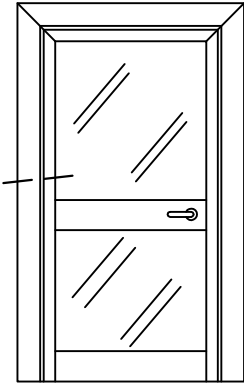



SEZIONE ORIZZONTALE

- Porta 1 anta Pannello 18 mm

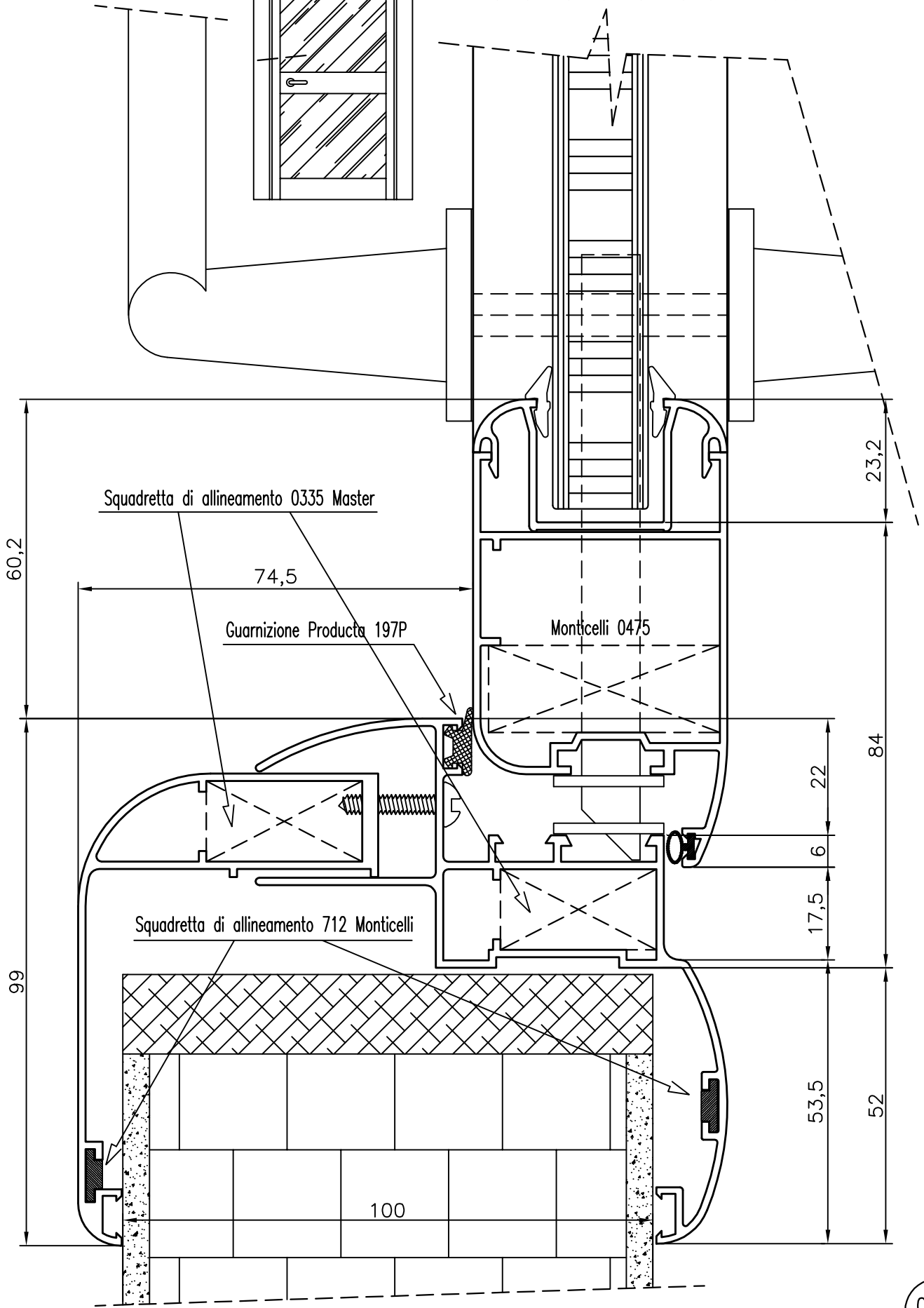

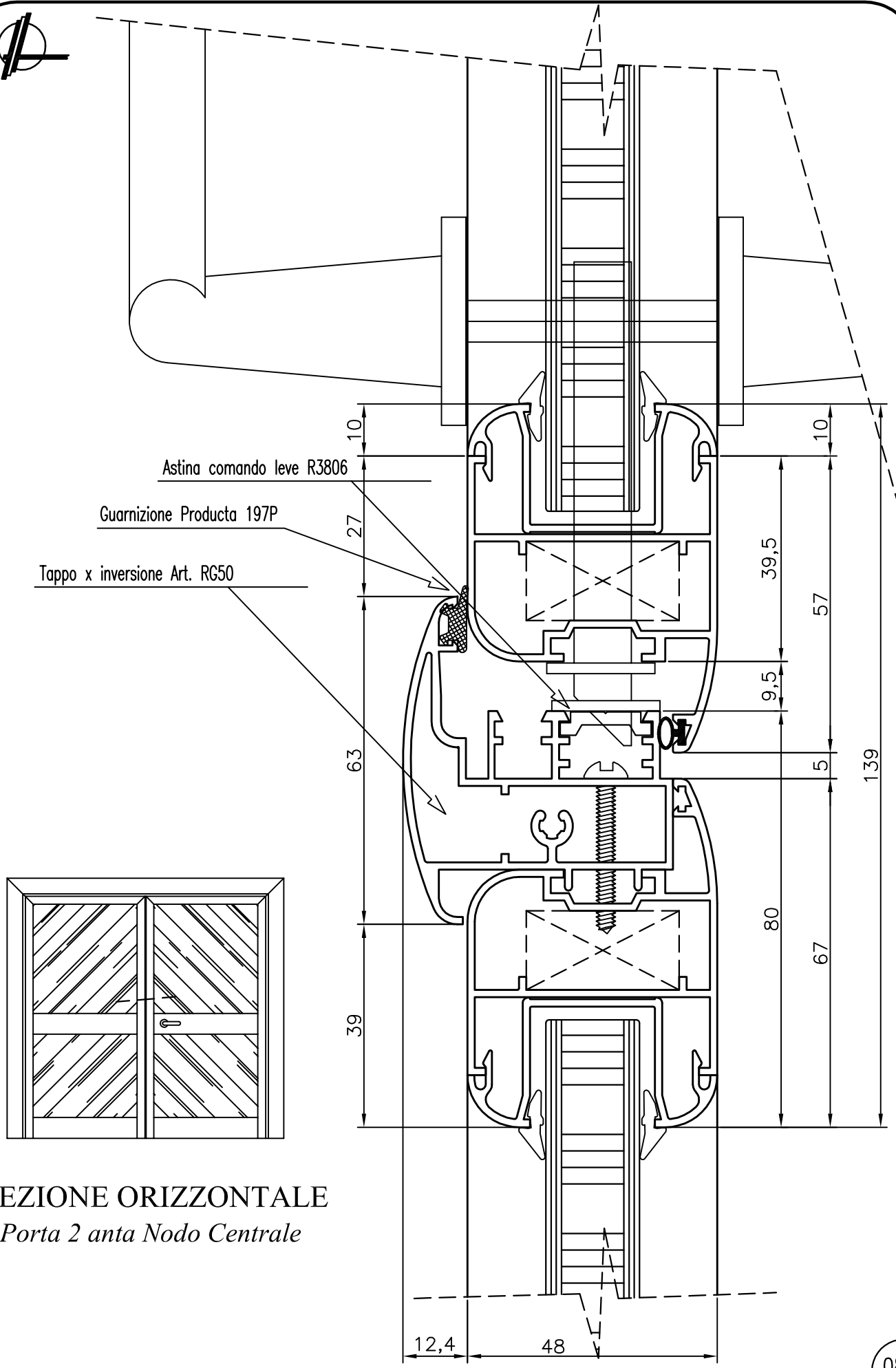

SEZIONE ORIZZONTALE
- Porta 2 anta Nodo Centrale

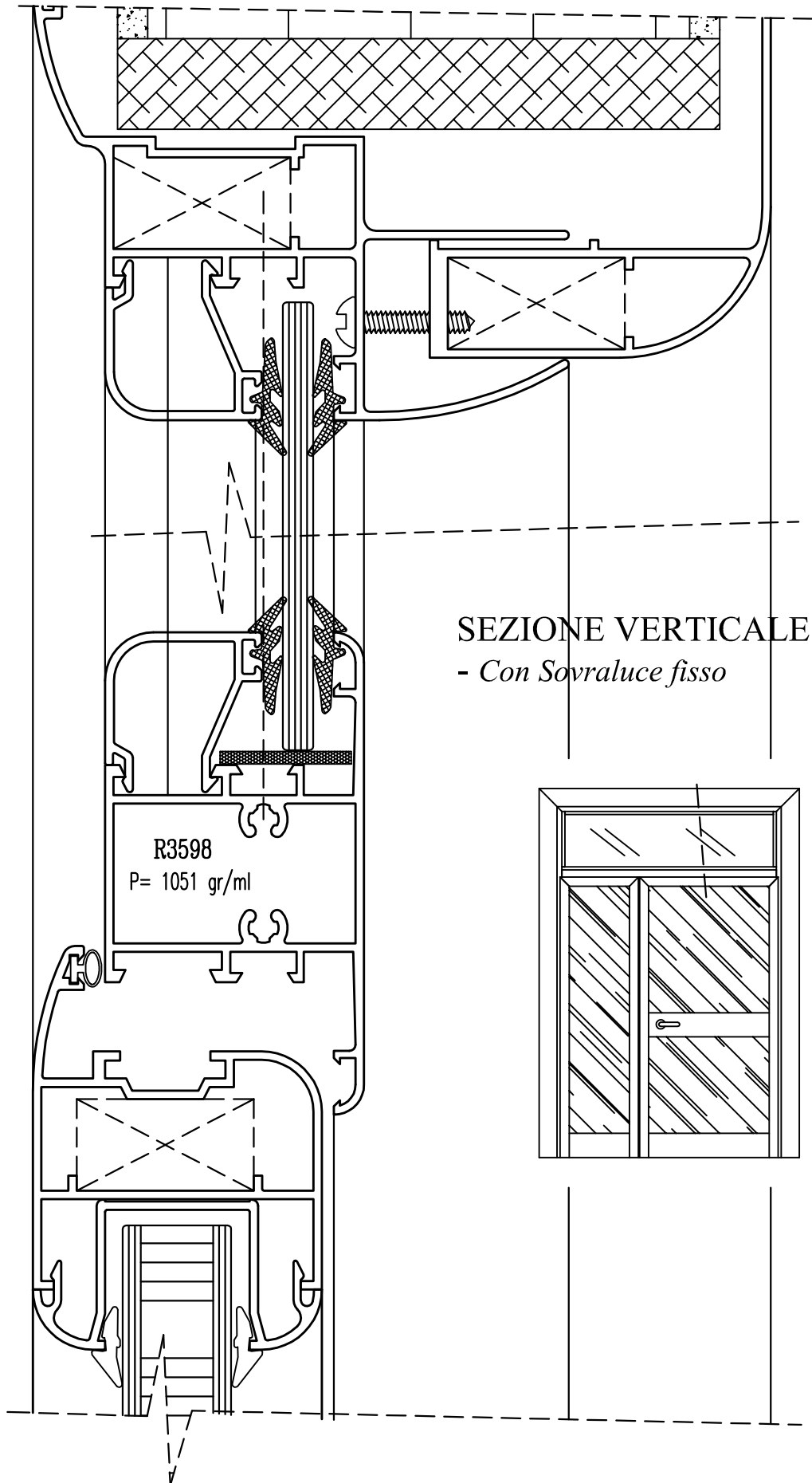

SEZIONE VERTICALE
- *Con Sovraluce fisso*

R3598
P= 1051 gr/ml

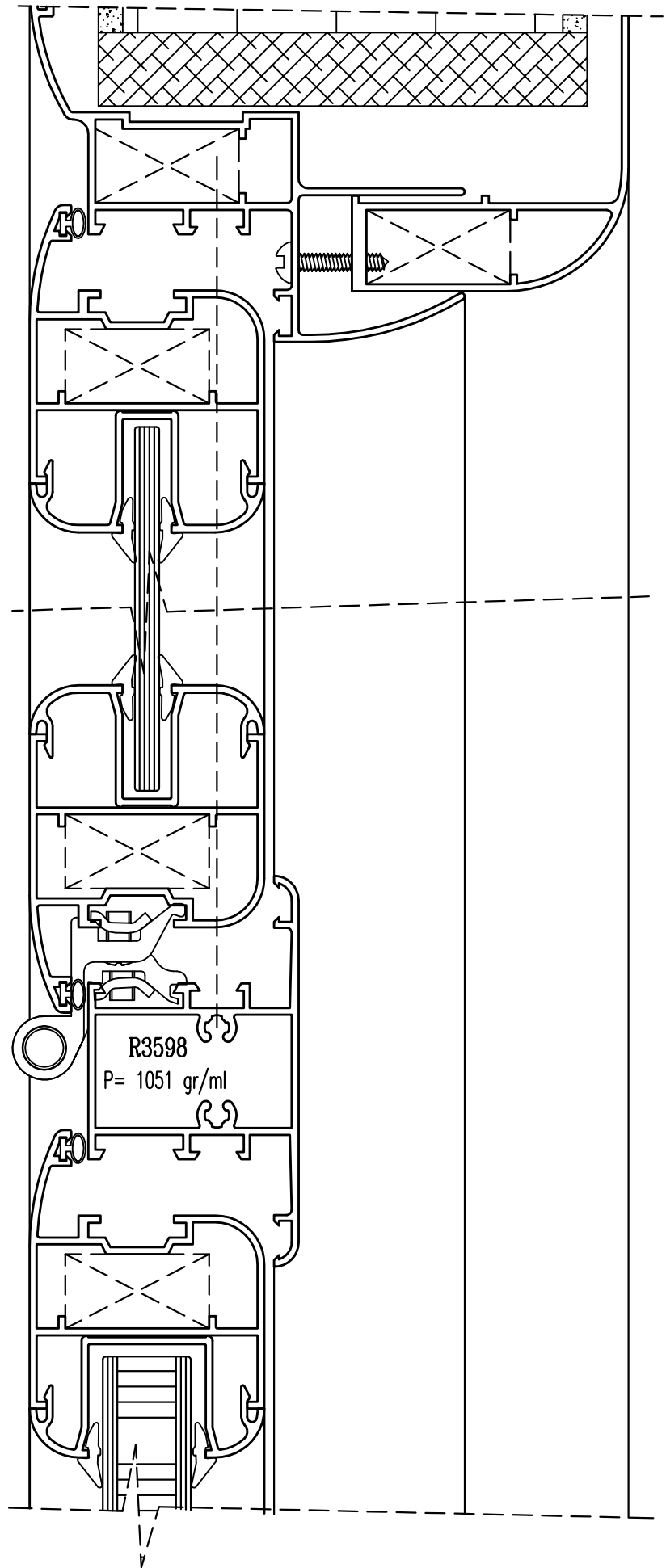

SEZIONE VERTICALE
- *Con Sovraluce Apribile*

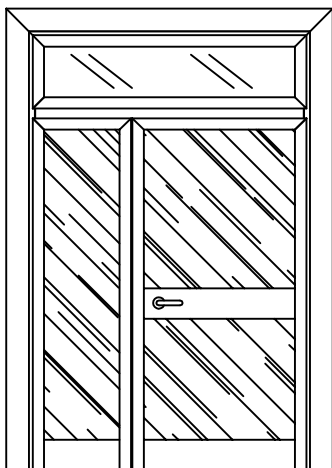



SEZIONE ORIZZONTALE - *Porta Pannello da 35mm 1 anta*

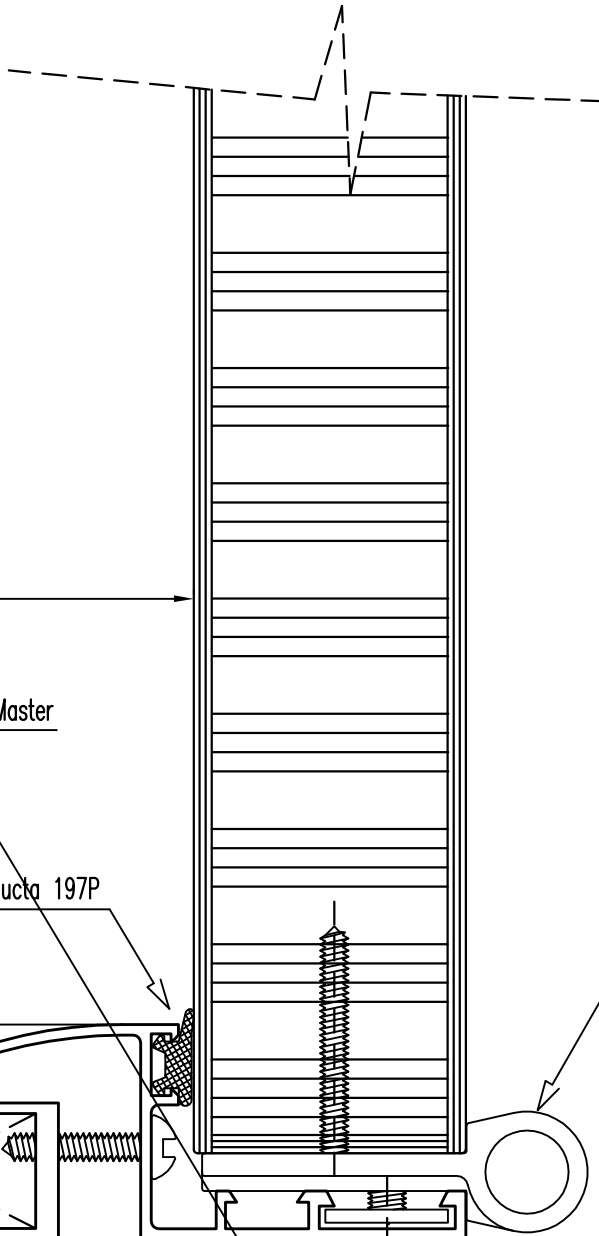
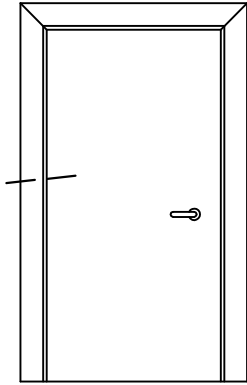

Squadretta di allineamento 0335 Master

Guarnizione Producta 197P

Cerniera Hy13B26

Squadretta di allineamento 712 Monticelli

99

100